

# VICTOR - 1159

COMPACT - 1800 W MSR



- **Type:** Followspot
- **Source:** 1800 W MSR
- **PSU:** Electronic - hot restrike
- **Optics:** 7° to 14.5° zoom

Followspot

## Compact but so powerful

With a combination of compact dimensions, high output to rival 2500 W followspots and a hot restrike lamp and electronic PSU, Victor is perfect for rental companies. It has become the new benchmark followspot for large theatres, TV studios, fashion shows, concerts and touring.

### Features

- **Fully closing iris cassette:** removable for fast, easy replacement; protective backplate for extended lifespan
- **Universal adjustable gobo holder:** "A" size glass and metal gobos
- **Ergonomic dimmer control:** one-handed dim, pan and tilt. Dimmer control can be adjusted to suit the operator's preference
- **Smooth dimmer shutter:** retains flat beam and colour temperature when dimming
- **Frost filter:** on flip lever for quick soft-edge beam effect
- **Horizontal chopper (optional):** for masking control in TV studios and wide stages
- **Internal glass filter holder:** long term use of durable coloured, dichroic or textured glass
- **Individually removable colour frame:** gels replaced easily while colour cassette remains in place
- **Colour changer:** 6-way, self-cancelling boomerang colour-changer
- **Easy focus reference:** graduated scale on side of the unit; fast and easy refocusing
- **Adjustable yoke (optional):** for optimum overhead positioning
- **Fine balance:** precision positioning and smooth operation even with the smallest movements
- **Stand:** perfectly weighted for maximum stability with smooth rotation for optimum performance. Easy set up; triple safety system for extra security

### Optical

- **Factory set optical train:** travels safely within followspot and requires no time-consuming realignment on arrival. Uniform beam on all followspots of same type
- **SX optical system:** double condenser optics for exceptional optical quality
- **Gobo :** excellent gobo projection
- **Variable zoom optics:** sharp focus at every beam angle. Independent control of image size and focus.

### Construction

- **Made in France :** fully manufactured in Robert Juliat premises retaining complete control over all aspects of quality
- **Separate PSU:** compact for easy handling and rapid maintenance
- **Bodywork:** strong sheet metal construction for durability
- **Ergonomic wrap-around handle:** comfort, safety and practicality from all operating positions
- **Moving parts:** smooth at all times, even when hot
- **Captive knobs and handles:** additional security when working at height or in transit
- **Easy access to all parts:** easy cleaning, re-lamping and maintenance
- **Removable assemblies:** fast-plug cable connectors and complete component assemblies (mirror, condenser set and lamp house assembly) save maintenance and cleaning time
- **Safety:** safety switch for secure access to the lamp

Picture:1159

DSEN107\_1159 - 13/09/2021

Robert Juliat reserves the right to change or alter any of the items detailed on this page, to increase or improve manufacturing techniques without prior notice.

Robert Juliat S.A.S., 32 rue de Beaumont, 60530 Fresnoy-en-Thelle - France  
Telephone : +33 (0)3 44 26 51 89 - fax : +33 (0)3 44 26 90 79 - info@robertjuliat.fr  
www.robertjuliat.com



ROBERT JULIAT

## Source



- **Lamp type:** Discharge
- **Power:** 1800 W
- **Socket:** SFc 15.5-6
- **Hot re-strike:** yes

| Admissible lamps       | Power * | Lumen output* | Colour temperature* | Life* | CRI* (min) |
|------------------------|---------|---------------|---------------------|-------|------------|
| MSR 1800W DE (Philips) | 1 800 W | 145 000 lm    | 6000K               | 750 h | 85         |
| KHD 1800W HR/DE (KLS)  | 1 800 W | 155 000 lm    | 6000K               | 750 h | 90         |

(\*) manufacturer's data

## Optics

### Characteristics

- **Type:** Zoom
- **Beam range:** 7° to 14.5°
- **Focal length:** 283 - 589 mm

### Gel filter

- **Shape:** Circle
- **Standard size:** 210 mm (8.3 in)

### Gobo

- **Size:** A
- **Material:** Metal  
Glass



## Photometrics

with MSR 1800W DE (Philips) source

### • Optics @ 7°

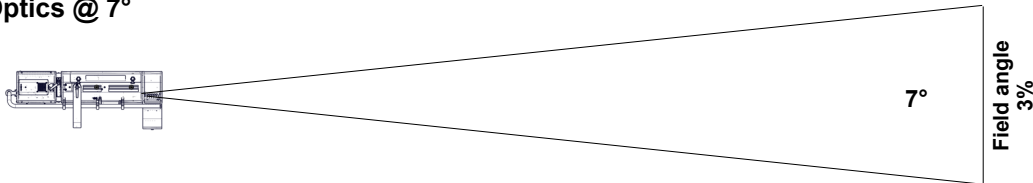

**Beam intensity**  
2 300 000 cd

|                     |           |           |           |         |         |         |
|---------------------|-----------|-----------|-----------|---------|---------|---------|
| <b>Distance</b>     | 20 m      | 30 m      | 40 m      | 50 m    | 60 m    | 70 m    |
| <b>Diameter</b>     | 2.4 m     | 3.7 m     | 4.9 m     | 6.1 m   | 7.3 m   | 8.6 m   |
| <b>Illumination</b> | 5 800 lux | 2 600 lux | 1 450 lux | 930 lux | 640 lux | 470 lux |
| <b>Distance</b>     | 65 ft     | 100 ft    | 130 ft    | 165 ft  | 195 ft  | 230 ft  |
| <b>Diameter</b>     | 8 ft      | 12.2 ft   | 15.9 ft   | 20.2 ft | 23.9 ft | 28.1 ft |
| <b>Illumination</b> | 550 fc    | 240 fc    | 140 fc    | 85 fc   | 65 fc   | 44 fc   |

### • Optics @ 14.5°

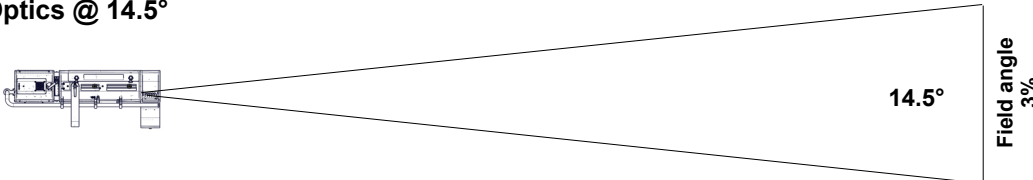

**Beam intensity**  
765 000 cd

|                     |           |         |         |         |         |         |
|---------------------|-----------|---------|---------|---------|---------|---------|
| <b>Distance</b>     | 20 m      | 30 m    | 40 m    | 50 m    | 60 m    | 70 m    |
| <b>Diameter</b>     | 5.1 m     | 7.6 m   | 10.2 m  | 12.7 m  | 15.3 m  | 17.8 m  |
| <b>Illumination</b> | 1 950 lux | 860 lux | 480 lux | 310 lux | 220 lux | 160 lux |
| <b>Distance</b>     | 65 ft     | 100 ft  | 130 ft  | 165 ft  | 195 ft  | 230 ft  |
| <b>Diameter</b>     | 16.5 ft   | 25.4 ft | 33.1 ft | 42 ft   | 49.6 ft | 58.5 ft |
| <b>Illumination</b> | 190 fc    | 80 fc   | 46 fc   | 29 fc   | 21 fc   | 15 fc   |

## Dimensions and weight

### Unit

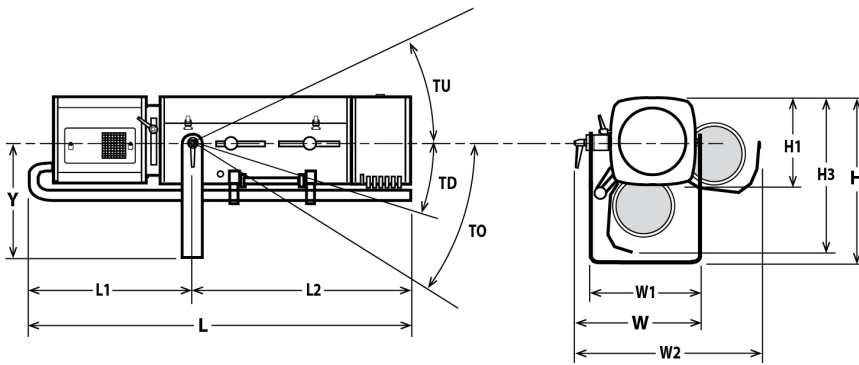

**Weight:** 33 kg (72.6 lbs)

| Height               | Length               | Width                | Yoke                | Tilt    | Option  |
|----------------------|----------------------|----------------------|---------------------|---------|---------|
| H= 450 mm (17.7 in)  | L= 1260 mm (49.6 in) | W= 410 mm (16.1 in)  | Y= 325 mm (12.8 in) | TU= 45° | TO= 65° |
| H1= 250 mm (9.8 in)  | L1= 580 mm (22.8 in) | W1= 350 mm (13.8 in) |                     | TD= 40° |         |
| H3= 460 mm (18.1 in) | L2= 680 mm (26.8 in) | W2= 570 mm (22.4 in) |                     |         |         |

### Shipping

• **Weight:** 82 kg (180.4 lbs)

• **Volume:** .58 m<sup>3</sup> (20.48 ft<sup>3</sup>)

### PSU

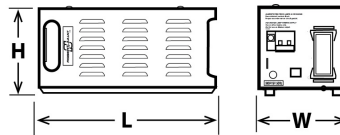

**Width:** W= 185 mm (7.3 in)

**Height:** H= 200 mm (7.9 in)

**Length:** L= 590 mm (23.2 in)

**Weight:** 13.2 Kg (29 lbs)

### Installation

• **Minimum distance to illuminated surface:** 3.5 m (11.5 ft)

• **Operating position:**



### Warranty

• **Fixture: 2 years**

See General Sales Condition on website

### Approvals



### Construction

- **Housing:** Steel sheet - Aluminium
- **Colour:** Black
- **Cooling:** Low noise fan
- **Maximum ambient temperature (Ta):** 40°C (104°F)
- **Maximum case temperature (Tc):** 230°C (446°F)
- **Total heat dissipation:** 6 963 BTU/h
- **Ingress Protection (IP) rating:** IP20

- **PSU housing:** Steel sheet - Aluminium
- **PSU colour:** Black
- **PSU cooling:** Fans
- **PSU maximum ambient temperature (Ta):** 40°C (104°F)
- **PSU maximum case temperature (Tc):** 50°C (122°F)

### Electrical compatibility

- 220/230 V - 50 Hz
- 245 V - 50 Hz
- ~~110/120 V - 60 Hz~~
- 208 V - 60 Hz
- 220/230 V - 60 Hz
- ~~100 V - 50 Hz~~
- ~~100 V - 60 Hz~~
- Selector: automatic detection

### Power input



- **Type:** removable power cord with Neutrik PowerCon® (ref. NAC3FCA) connector (included)
- **Cable:** H07RNF 3G1.5
- **Length:** 3 m (9.8 ft)
- **Power connector:** CEE 7/7 (2P+E NF/Schuko)

### Power consumption

| Voltage | Frequency | Current | Power  | Power factor |
|---------|-----------|---------|--------|--------------|
| 230 V   | 50 Hz     | 8.9 A   | 2040 W | 0.98         |
| 208 V   | 60 Hz     | ?       | 2040 W | 0.97         |
| 245 V   | 50 Hz     |         |        |              |

### Power Supply Unit

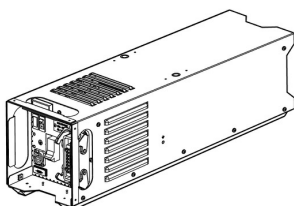







- **PSU:** Separate - Electronic PSU - Flicker free with PFC
- **Lighting unit / PSU cable:** Cable attached to unit - length: 3 m (9,8 ft)  
Type: 18G1,5 JZ 602-RC (CE-UL/CSA) with 16x16A+E Harting Han® connector
- **Maximum distance between lighting unit and PSU:** 25 m (82 ft)
- **Control:** Local
- **Protection:** Mains: 16A 2P2D - C curve breaker / Electronic: 2A 5x20 T fuse





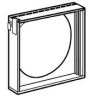

## Model



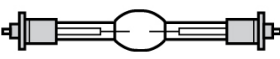
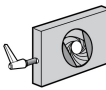







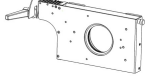



|             |  |
|-------------|--|
| <b>1159</b> | 1800 W MSR Followspot - 1159 Victor - 7/14.5° - Electronic PSU |
|-------------|--|



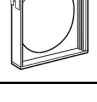
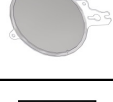

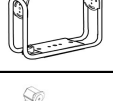
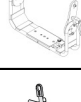
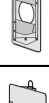
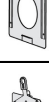

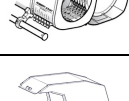
## Options

|                   |   |   |
|-------------------|---|---|
| <b>PCP1716A</b>   | 16A blue 2P+E 6h IEC60309 power connector   |    |
| <b>FRO/1117PV</b> | Heavy duty adjustable yoke  |    |
| <b>FRO/SMDPV</b>  | Heavy duty adjustable yoke equipped with TILT SpotMe sensor (D type)                                  |    |
| <b>PG80</b>       | Ø80mm chopper kit (G80+ GR120+ adaptation kit)  |    |
| <b>M210TM</b>     | 6 ways "push/pull" colour changer   |    |
| <b>CAV700P1</b>   | Double slot front cassette for 215x215mm accessories (instead of "boomerang" colour changer)          |    |
| <b>CAG/C</b>      | Left side controls option for Compact range (Iris/Dimmer/Frost/Colour changer)                        |   |
| <b>FC1459</b>     | Flight-case for Compact range / GT stand / P.S.U. / accessories - Dim: 1340x710x700mm - Weight: 55 Kg |  |

## Accessories

|                        |   |   |
|------------------------|---|---|
| <b>KHD 1800W HR/DE</b> | KHD 1800W HR/DE - KLS SFc 15.5-6 1800W 750h 6000K lamp<br><b>1 included</b>       |  |
| <b>CCU1</b>            | Full closing iris cassette - Ø72mm - Poids: 1.33 Kg<br><b>1 included</b>          |  |
| <b>PF1011</b>          | Ø210 mm metal filter holder<br><b>6 included</b>                                  |  |
| <b>SGUP2</b>           | Universal "A" size gobo-holder (metal, glass, frosted glass)<br><b>1 included</b> |  |
| <b>FACM100</b>         | Ø97mm UV/IR filter with holder<br><b>1 included</b>                               |  |
| <b>VDM100</b>          | Ø97mm frosted glass with holder<br><b>1 included</b>                              |  |
| <b>M210B</b>           | 6 ways "boomerang" colour changer - Poids: 3.36 Kg<br><b>1 included</b>           |  |
| <b>TC1149</b>          | Tool case with spare parts - Poids: 1.65 Kg<br><b>1 included</b>                  |  |

|                   |   |   |
|-------------------|---|---|
| <b>CCU1SM</b>     | Full closing iris cassette with position sensor for SpotMe system - Ø72mm   |       |
| <b>GT1000</b>     | Tripod stand - SWL: 40 Kg - max. height: 1550 mm - Poids: 9.27 Kg   |    |
| <b>GT4000</b>     | Tripod stand with safety chain - SWL: 130 Kg - max. height: 1030 mm - Poids: 7.91 Kg                                |    |
| <b>GT4000RSM</b>  | Tripod stand with ball head rotation with security chain and SpotMe PAN sensor - SWL: 130 Kg - max. height: 1030 mm |    |
| <b>GT4000S</b>    | Tripod stand without safety chain - SWL: 130 Kg - max. height: 1030 mm - Poids: 8.65 Kg                             |    |
| <b>JPP</b>        | Monopod stand for overhead followspot - Poids: 3.6 Kg   |    |
| <b>T1000</b>      | TV spigot with followspots swivel head - Poids: 1.82 Kg   |    |
| <b>T4000</b>      | Followspot mount for Ø50mm pipe (suspension or overhead) - SWL= 100 Kg - Poids: 4.88 Kg                             |    |
| <b>T4000RSM</b>   | Followspot mount with ball head rotation and SpotMe PAN sensor - SWL = 100 Kg - Poids: 8.53 Kg                      |   |
| <b>CAV700A</b>    | Double slot front cassette for 215x215mm accessories - Poids: 0.52 Kg   |  |
| <b>FCM100R</b>    | Ø97mm 1/2 CTO correction filter (Rosco #3408) with holder   |  |
| <b>VD120</b>      | 120x120mm frosted glass   |  |
| <b>FRO/1017PD</b> | Heavy duty adjustable yoke - Poids: 4.33 Kg   |  |
| <b>FRO/SMDPD</b>  | Heavy duty adjustable yoke equipped with TILT SpotMe sensor (D type)  |  |
| <b>G80</b>        | Ø80mm horizontal chopper - Poids: 0.37 Kg   |  |
| <b>GR120</b>      | Slot reducer for SGUP gobo holder (if PG80 option ) - Poids: 0.2 Kg   |  |
| <b>Kit G80</b>    | Ø80mm chopper kit (G80+ GR120+ adaptation kit) - Poids: 0.69 Kg   |  |
| <b>M210T</b>      | 6 ways "push/pull" colour changer - Poids: 3.67 Kg  |  |
| <b>M210TVCL</b>   | Light shield for M210T push/pull colour changer - Poids: 1.98 Kg  |  |

|                   |  |   |
|-------------------|--|---|
| <b>Kit TELRAD</b> | Telrad followspot sight with raiser and universal mounting kit -<br>Poids: 1.23 Kg |   |
| <b>SDUP</b>       | Followspot cue sheet holder with universal mounting kit                            |  |
| <b>TCSM</b>       | SpotMe calibration tool kit  |  |
| <b>Maestro</b>    | Maestro server for SpotMe - rackable unit: 1U - half 19" - Poids: 1.2 Kg           |  |
| <b>SMS</b>        | SpotMe server + 2 sensor cables + flight case                                      |  |
| <b>FC1459/S</b>   | Flight-case for Compact range / GT stand / P.S.U. / accessories -<br>Poids: 55 Kg  |  |